

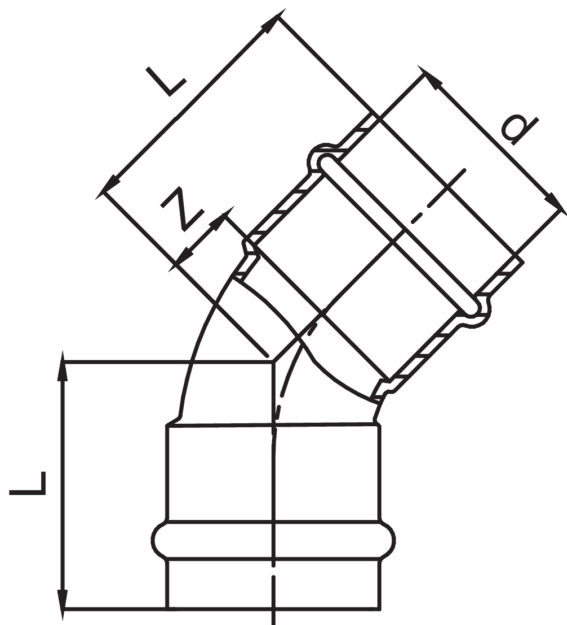

Curva 45° femmina.

Specifiche tecniche



| D | BAG | MASTER BOX | CODICE | L | Z |
|----|-----|------------|-----------------|----|----|
| 15 | 10 | 100 | GX0041015015000 | 29 | 7 |
| 18 | 5 | 30 | GX0041018018000 | 46 | 23 |
| 22 | 5 | 50 | GX0041022022000 | 34 | 10 |
| 28 | 5 | 40 | GX0041028028000 | 38 | 13 |
| 35 | 5 | 40 | GX0041035035000 | 43 | 17 |
| 42 | 1 | 20 | GX0041042042000 | 53 | 17 |
| 54 | 1 | 5 | GX0041054054000 | 69 | 29 |

Applicazioni



GAS



COMPRESSED
AIR



INDUSTRIAL