

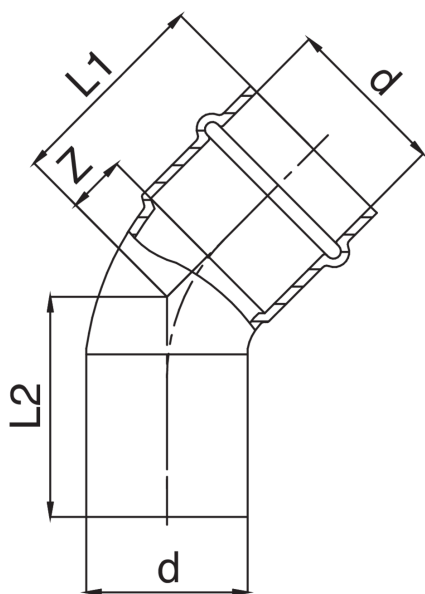

Curva 45°maschio-femmina.



Specifiche tecniche



D	BAG	MASTER BOX	CODICE	L1	L2	Z
12	10	250	RS9040012012000	25	26	7
15	10	200	RS9040015015000	29	30	7
18	10	150	RS9040018018000	31	32	8
22	10	100	RS9040022022000	34	36	10
28	5	60	RS9040028028000	38	40	13
35	5	40	RS9040035035000	43	45	17
42	5	20	RS9040042042000	53	55	17
54	1	10	RS9040054054000	68	70	28

Applicazioni



DRINKING
WATER



HEATING



HVAC



GAS



COMPRESSED
AIR



FIREFIGHTING