

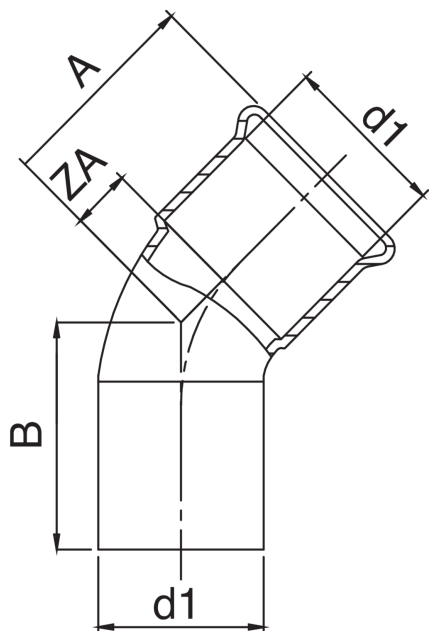

Curva 45° maschio-femmina.

Specifiche tecniche



D1	BAG	MASTER BOX	CODICE	A	B	ZA
76,1*	1	10	AC0040076076000	93	104	38
88,9*	1	6	AC0040089089000	104	115	44
108*	1	2	AC0040108108000	124	136	68

* Profilo M.

Applicazioni



HEATING



HVAC



COMPRESSED
AIR