

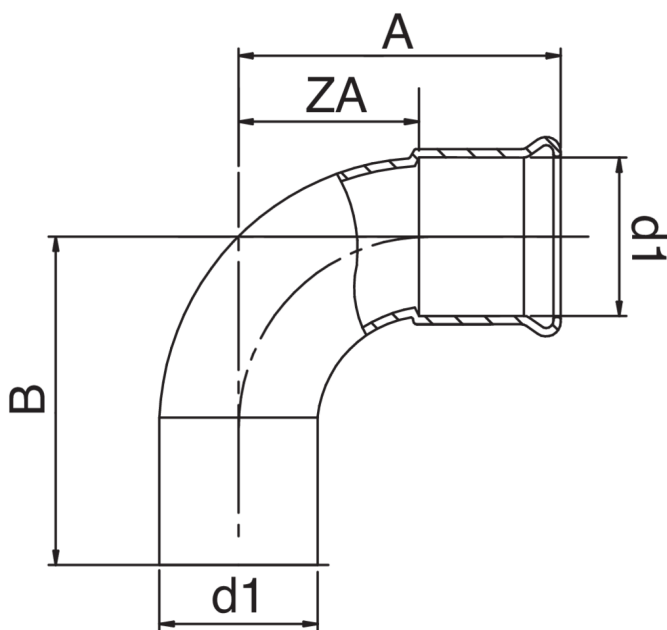

Courbe 90° M/F.

## Spécifications techniques



D1	BAG	MASTER BOX	CODE	A	B	ZA
15	10	100	GM0001015015000	39	45	19,5
18	10	100	GM0001018018000	43	49	23,5
22	5	70	GM0001022022000	48	54	25,5
28	5	40	GM0001028028000	57	63	34,5
35	5	10	GM0001035035000	68	74	42,5
42	1	10	GM0001042042000	83	89	53,5
54	1	4	GM0001054054000	102	108	67,5

## Applications



GAS



COMPRESSED  
AIR



INDUSTRIAL