

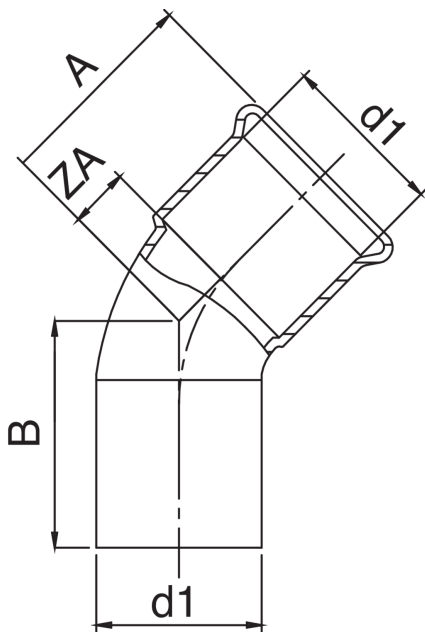

Curva 45° M/H.



## Especificaciones técnicas



D1	BAG	MASTER BOX	CÓDIGO	A	B	ZA
15	10	40	MX0040015015000	29	30	9,5
18	10	100	MX0040018018000	31	32	11,5
22	10	60	MX0040022022000	34	35	11,5
28	5	40	MX0040028028000	38	39	15,5
35	5	30	MX0040035035000	43	44	17,5
42	1	20	MX0040042042000	53	54	23,5
54	1	10	MX0040054054000	69	70	34,5

## Aplicaciones



DRINKING  
WATER



HEATING



HVAC



COMPRESSED  
AIR



FIREFIGHTING



MARINE



STEAM



SOLAR



INDUSTRIAL