

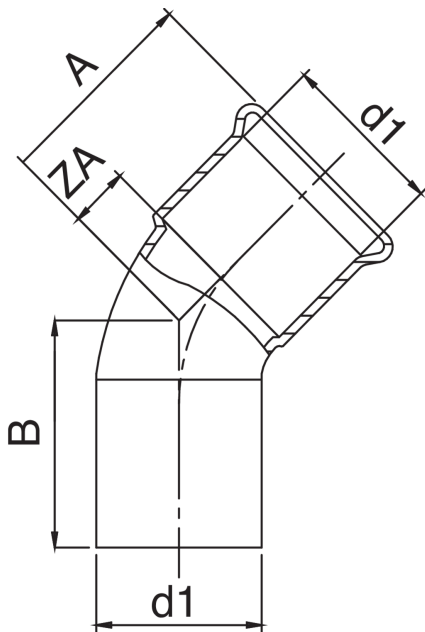

Curva 45° M/H de cobre.

## Especificaciones técnicas



D1	BAG	MASTER BOX	CÓDIGO	A	B	ZA
12	10	250	QM9040012012000	23	30	5
15	10	200	QM9040015015000	28	37	8
18	10	150	QM9040018018000	29	37	9
22	10	100	QM9040022022000	34	42	11
28	5	60	QM9040028028000	37	42	14
35	5	40	QM9040035035000	44	46	18
42	5	20	QM9040042042000	51	68	21
54	1	10	QM9040054054000	62	72	27

## Aplicaciones



COMPRESSED  
AIR



GAS



INDUSTRIAL