

Copper M/F 45° elbow.

## Technical specifications

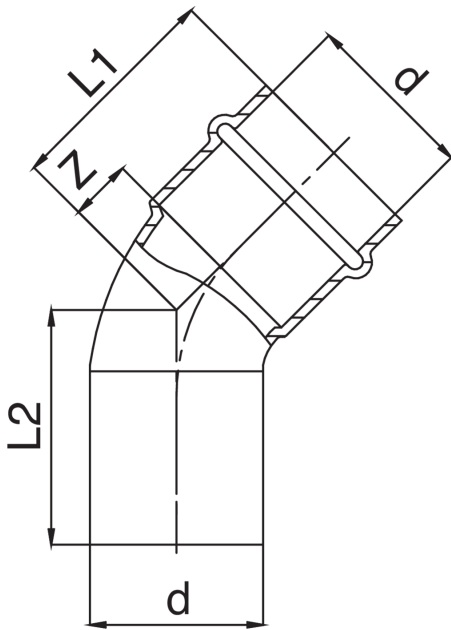

| D  | BAG | MASTER BOX | CODE            | L1 | L2 | Z  |
|----|-----|------------|-----------------|----|----|----|
| 12 | 10  | 250        | PG9040012012000 | 25 | 26 | 7  |
| 15 | 10  | 200        | PG9040015015000 | 29 | 30 | 7  |
| 18 | 10  | 150        | PG9040018018000 | 31 | 32 | 8  |
| 22 | 10  | 100        | PG9040022022000 | 34 | 36 | 10 |
| 28 | 5   | 60         | PG9040028028000 | 38 | 40 | 13 |
| 35 | 5   | 40         | PG9040035035000 | 43 | 45 | 17 |
| 42 | 5   | 20         | PG9040042042000 | 53 | 55 | 17 |
| 54 | 1   | 10         | PG9040054054000 | 68 | 70 | 28 |

## Applications



GAS



INDUSTRIAL



COMPRESSED  
AIR