

Bogen 90° 1/1 aus Kupfer.

## Technische Spezifikationen

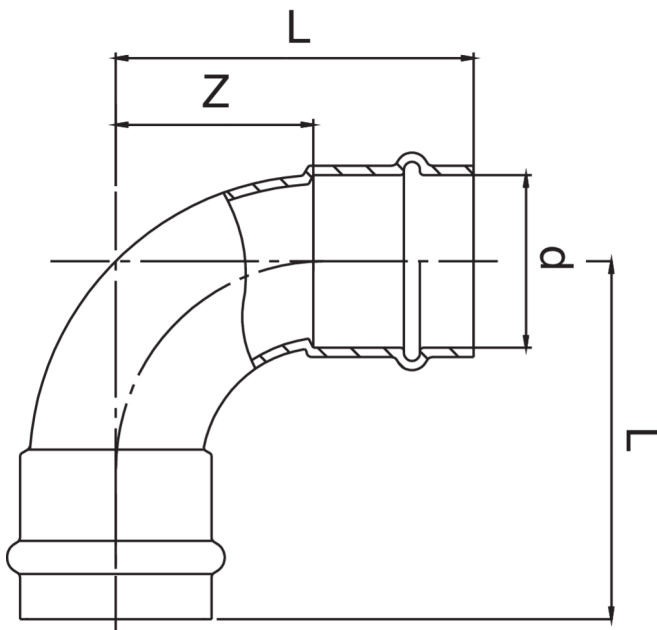

| D  | BAG | MASTER BOX | CODE            | L   | Z  |
|----|-----|------------|-----------------|-----|----|
| 12 | 10  | 250        | PG9002012012000 | 33  | 15 |
| 15 | 10  | 150        | PG9002015015000 | 40  | 18 |
| 18 | 10  | 100        | PG9002018018000 | 45  | 22 |
| 22 | 10  | 60         | PG9002022022000 | 47  | 23 |
| 28 | 5   | 40         | PG9002028028000 | 59  | 34 |
| 35 | 5   | 20         | PG9002035035000 | 68  | 42 |
| 42 | 1   | 10         | PG9002042042000 | 87  | 51 |
| 54 | 1   | 7          | PG9002054054000 | 105 | 65 |

## Anwendungen



GAS



INDUSTRIAL



COMPRESSED  
AIR